



PROSENSE

Safevader Series Gas Detector

User Manual



Prosense Teknoloji San. Ltd. Şti.
Cumhuriyet Mah. Mermer sok. No:16 Kartal İstanbul
Tel: (90) 216 306 77 88 Faks: (90)216 473 81 29
www.prosense.com.tr

WARNING!

READ THIS INSTRUCTION FIRST!

This manual must be carefully read by all persons who have or will have the responsibility for installing, using or servicing this product.

Like any equipment, this product will perform as designed only if installed, used and serviced in accordance with the manufacturer's instructions. Otherwise, it could fail to perform as designed and persons who rely on this product for their safety could suffer severe personal injury or death.

The warranties made by Prosense with respect to this product are voided if the product is not installed, used and serviced in accordance with the instructions in this user guide. Please protect yourself and other by following them.

CAUTION

This product has been tested and approved for use in safe areas and should not be used in hazardous areas. Any device modification, improper installation, or use in a faulty or incomplete configuration will render warranty and product certifications invalid.

Important Remark

The detector has been factory-tested before delivery. The commissioning has to be terminated by a function test of the complete gas detection system.



ELECTROSTATIC HAZARD - CLEAN ONLY WITH A DAMP CLOTH!

Contents

Safety Information.....	5
Strictly follow the Instructions for Use.....	6
Maintenance.....	6
Use in areas subject to explosion hazards	6
Liability for proper function or damage	6
Intended Use	6
Introduction.....	8
Detector body.....	9
Installation.....	9
Mounting the detector.....	10
Electrical connections.....	11
Detector grounding	13
SafeVader Outputs	14
4-20 mA output:	14
RS485 serial communication output:	15
Relay Outputs:.....	15
System Status	16
Indication of measured values	17
Warmup.....	17
Fault.....	17
Alarm	17
Calibration	18
Underrange.....	18
Overrange.....	18
Analogue Output State:.....	19
Switching Output State.....	20
Commissioning	21
Commissioning SafeVader.....	21
Detector Settings.....	22
Entering the menu:.....	22
Menu structure.....	23
Alarm Settings	24
Configure	25
Change Modbus address	25
Change Analogue Output	25
Display Parameters.....	26
Change Language.....	26
Change Zero Suppression	26
Change password	27

Information Menu options	28
Display Measurements	28
Display Transmitter information	28
Display Sensor information	28
Test Menu Options	29
Run Inhibit test	29
Run Display test	29
Run Relay test	29
Run Analogue Output test	30
Calibration	31
Set Reference Gas details	32
Zero Calibration	33
Span Calibration	33
Cancel Calibration	34
Maintenance	35
Proactive maintenance:	35
Operational Life:	35
Sensor module replacement:	35
Detector Transmitter board replacement:	36
Display Module replacement:	36
Fault Status Codes:	37
General specification	38
Electrical Specifications:	38
Detector Body Specifications:	38
Environmental:	38
Default Configuration:	39
Warranty statement	40
Exclusions	40
Warranty Limitation and Exclusion	40
Limitation of Liability	41

Safety Information

FOR SAFETY REASONS THIS EQUIPMENT MUST BE OPERATED AND SERVICED BY QUALIFIED PERSONNEL ONLY. READ AND UNDERSTAND INSTRUCTION MANUAL COMPLETELY BEFORE OPERATING OR SERVICING.

CAUTION

A HIGH OFF-SCALE READING MAY INDICATE EXPLOSIVE CONCENTRATION.

Observe these precautions:

- To minimize the risk of electrostatic charge, provision shall be made for adequate grounding and equipment shall be installed in such a manner so that accidental discharge shall not occur.
- When Prosense SAFEVADER reaches the end of its life, it should be disposed of in accordance with local regulations.
- Do not use cleaning solvents or abrasives to clean the gas detector.
- Do not attempt to modify the product in any way from the manufacturers design or specification. Warranty will be void and malfunction of the gas detector may result.
- Use only genuine spare parts and accessories with Prosense SAFEVADER. Malfunction may result if non-standard parts are used.

WARNING

- Prosense SAFEVADER is designed for installation and use in safe areas.
- Installation must be in accordance with the recognized standards of the appropriate authority in the country concerned.
- Access to the interior of the detector, when carrying out any work, must only be conducted by trained personnel.
- Before carrying out any work ensure local regulations and site procedures are followed.
- In order to maintain electrical safety, the product must not be operated in atmospheres with more than 21% oxygen. Oxygen deficient atmospheres (Combustible: less than 10%V/V, Toxic: less than 6%V/V) may suppress the sensor output.
- Never attempt to open the enclosure or replace/refit the sensor in potentially hazardous atmospheres or while power is still applied to the transmitter.
- The detector must be earthed/grounded for electrical safety and to limit the effects of radio frequency interference. Earth/ground points are provided inside the unit. The internal grounding shall be used as the primary equipment ground.
- Ensure that all screens/instrument earth/clean earth wiring is earthed/grounded at a single point (either at the controller or detector, BUT NOT BOTH) to prevent false readings or alarms that may occur due to potential earth/ground loops.
- Take care when handling sensors as they may contain corrosive solutions. Do not tamper with or in any way disassemble the sensor.
- Do not expose to temperatures outside the recommended ranges.
- Do not expose sensors under storage conditions to organic solvents or flammable liquids.
- At the end of their working life, replaceable electrochemical sensors for oxygen and toxic gas must be disposed of in an environmentally safe manner. Disposal should be according to local waste management requirements and environmental legislation.

- Electrochemical sensors should NOT be incinerated as this action may cause the cell to emit toxic fumes.
- Refer to the local or national regulations relative to the installation at the site. For Europe see EN60079-29-2, EN60079-14, EN45544-4 and EN61241-14. For installations in North America, the National Electrical Code (NFPA 70) should be strictly observed. All the appropriate local and national regulations should be observed.
- The pellistors used in the catalytic flammable gas sensor can suffer from a loss of sensitivity when in the presence of poisons or inhibitors, e.g. silicones, sulphides, chlorine, lead, or halogenated hydrocarbons.

Ensure that this Operating Manual is read and understood **BEFORE** installing / operating / maintaining the equipment. Pay particular attention to Warnings and Cautions. All document Warnings are listed here and repeated where appropriate at the start of the relevant chapter(s) of this Operating Manual. Cautions appear in the sections/sub-sections of the document where they apply.

Strictly follow the Instructions for Use

Any use of the detectors requires full understanding and strict observation of these instructions. The detector is only to be used for purposes specified here.

Detectors must be protected from extreme vibration and direct sunlight in hot environments as this may cause the temperature of the detector to rise above its specified limits and cause premature failure.

Maintenance

It is recommended to obtain a service contract Prosense to carry out all repairs. Only authentic Prosense spare parts must be used, substitute components may invalidate the certification and warranty of the detector. Maintenance and calibration operations must only be performed by qualified service personnel.

Use in areas subject to explosion hazards

Use in areas subject to explosion hazards is not permitted.

Liability for proper function or damage

The liability for the proper function of the detector is irrevocably transferred to the owner or operator to the extent that the detector is serviced or repaired by personnel not employed or authorized by Prosense or if the sensing part is used in a manner not conforming to its intended use. Prosense cannot be held responsible for damage caused by non-compliance with the recommendations given above. The warranty and liability provisions of the terms of sale and delivery of Prosense are likewise not modified by the recommendations given above.

Intended Use

The SAFEVADER series detectors are intended to be used for stationary, continuous monitoring for combustible gas/air or vapour/air mixtures below the Lower Explosion Limit (LEL) and toxic

gas/air mixtures in particule per million (PPM) and Oxygen and CO₂ in volume (VOL) units. The enclosure protection is IP 65. For the determination of the measuring range and operating conditions, the label on the detector should be consulted.

Not to be used in oxygen enriched atmospheres.

In conjunction with the central controllers Prosense detectors with preadjusted alarm thresholds audible and visible alarm devices or automatic countermeasures can be activated before the detected gases or vapours can form dangerous flammable or toxic mixtures with air. SAFEVADER series with pellistor sensor for flammable gas detectors are designed to detect gases or vapours in air and not inert or oxygen deficient atmospheres. Please be alerted in following special conditions may have impact on measuring function due to the nature of measuring method:

1. Very high gas concentrations

The measuring method of SAFEVADER series detector based on heat produced by reaction on the oxidation of a flammable gas when pellistor sensor used. There is not enough oxygen in the sensor to perform oxidation process correctly in case of high gas concentrations. Hence the measuring signal decreases at high gas concentrations and even can lead to measuring signal within the measuring range again. In case of high flammable gas concentration, do not reset latching alarms without having ensured a safe condition in the environment via performing necessary checks.

2. Minimum oxygen concentration

The measuring principle of heat of reaction needs a minimum oxygen concentration of 12 % by volume for SAFEVADER series detector with pellistor sensor; otherwise the measuring values will be too low because of oxygen deficiency.

3. Long-term gassing with methane at very low temperatures

If the Prosense SAFEVADER series flammable gas detectors with pelistör sensor are operated applying with methane at very low temperatures, the measuring signal at long term exposition may decrease after alarm activation and may lead to misinterpretation.

If a gas alarm occurs, necessary actions need to be taken immediately. The decrease of the measuring signal should not mean that the gas concentration has been decreased. We recommend to keep alarms on the associated controllers and not to reset these alarms without performing measurement with an independent gas detector to make sure conditions are safe.

4. Avoid exposure to Silicon complex

Prosense pellistor sensors high level of resistance to catalytic poisons like Hydrogen Sulphide (H₂S) and Silicones such as HMDS (HexaMethylDiSiloxane). But it is not suitable to use in environments which continuous exposure of poisoning elements.

Introduction

The Prosense comprises a gas detector body and a choice of sensors heads for detecting flammable gases, toxic gases and oxygen. The construction of Prosense SAFEVADER Series detectors allows it to be used in areas not classified as hazardous.

Prosense SAFEVADER Series detectors can be configured with a wide range of different sensors may be used to detect a broader range of target gases. The detector provides an industry standard 3-wire, 4-20mA output for connection to a dedicated gas detection control system or PLC. It can also provide RS485 serial communication with integrated onboard devices.

Prosense SAFEVADER series provides on board three relays to use as switching output which are FAULT, ALARM1 and ALARM2. Relay switching outputs can be used for controlling external equipment e.g. alarms, sirens, valves or switches.

Prosense SafeVader detectors comprises of the main parts as shown below:

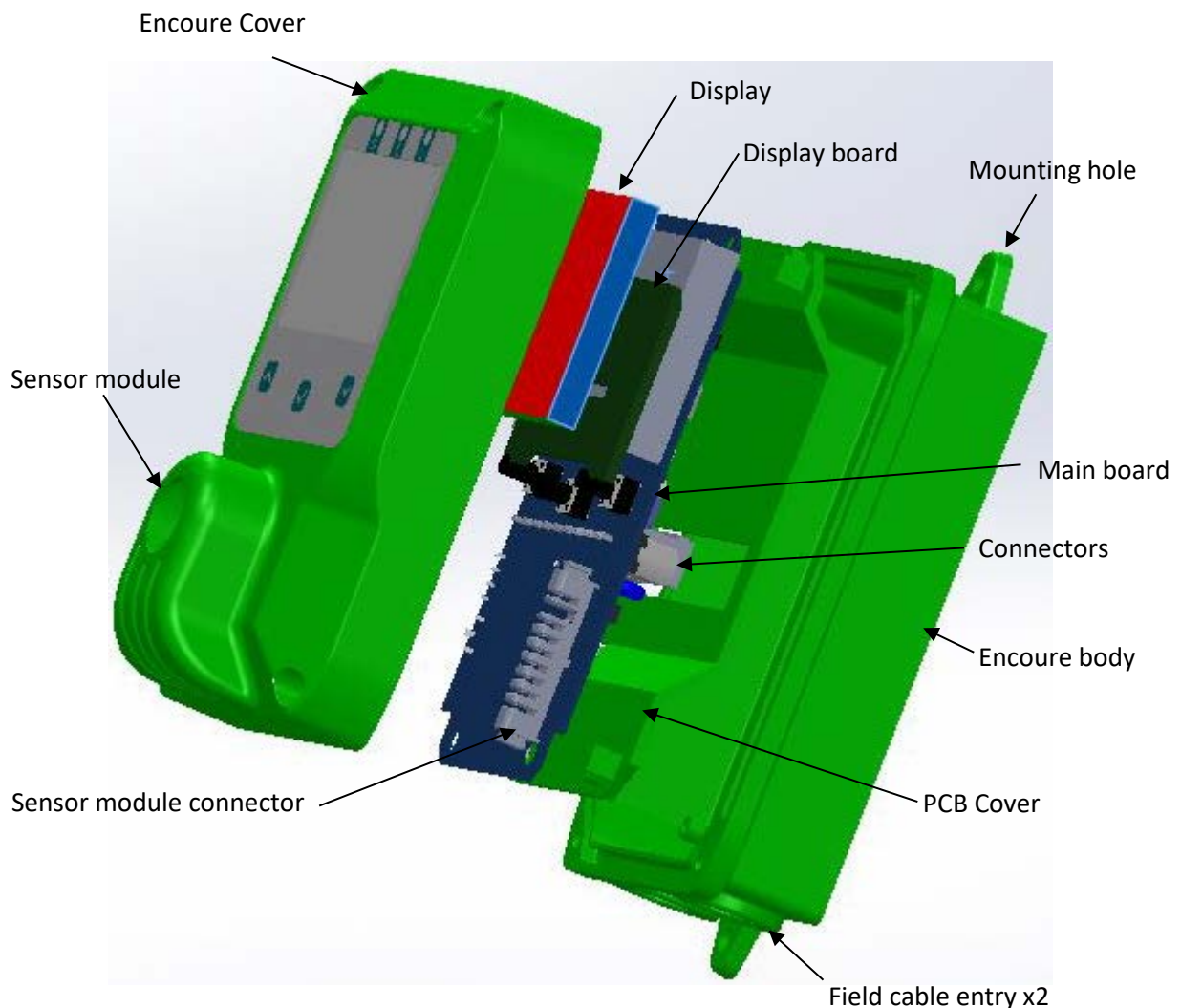

Diagram 1: Exploded view of SafeVader detector

Detector body

The detector enclosure has two cable entries located at the bottom of enclosure for connecting the power source, signal output and relay contacts to associated signalling equipment. There are two mounting holes incorporated into the transmitter housing.

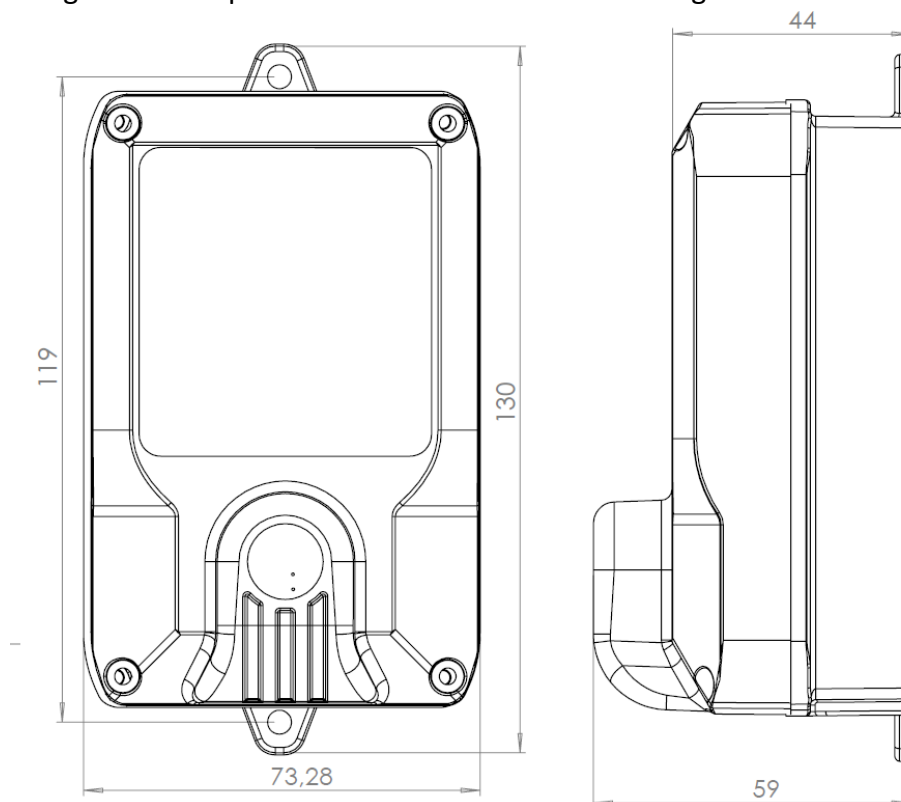

Diagram 2: Detector body and size (mm)

Installation

Gas detectors should be mounted where a potential hazard of gas is most likely to be present. The following points should be noted when locating gas sensors.

- When locating detectors consider the possible damage caused by natural events e.g. rain or flooding.
- Consider ease of access to the gas detector for functional testing and servicing.
- Consider how escaping gas may behave due to natural or forced air currents.

Note: The placement of gas detectors should be determined following the advice of experts having specialist knowledge of gas dispersion, experts having knowledge of the process plant system and equipment involved safety and engineering personnel. The agreement reached on the location of detectors should be recorded.

Each gas has different nature depending on their density. The density of which is lower than air, such as hydrogen, methane or ammonia the sensor head must be located above a possible leak or at the highest points at which major concentrations of gas may be found. The gases and vapours with a density greater than air, the sensor head must be installed beneath a possible leak or at the lowest points at which such gases and vapours may be present.

Mounting the detector

The detector must be mounted vertically as the sensor pointing forward. Detector has to be mounted such that the sensor's gas entrance area. The install location

- should be isolated from vibration, direct sun light and have temperature stability
- avoided external influences such as splashing water, oil, corrosive aerosols
- should have at least 30 cm free space beneath the sensor head to provide accessibility for calibration work.
- should be in air flow between possible leak or collection point and possible source of ignition.

Prosense do not recommend installing detectors to:

- directly above a cooking unit,
- directly above a sink unit,
- close to an extractor unit,
- outdoor without protection against the rain,
- in places where temperature is outside the admissible operating range,
- corrosive environments,
- inside air vents.
- environments where silicon can be found.

Prosense SAFEVADER series detector has two mounting holes on detector body to fix detector directly to a surface:

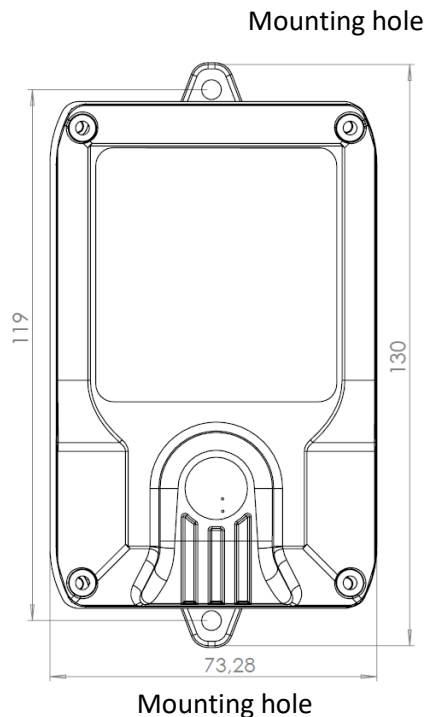

Diagram 3: Mounting holes

Electrical connections

CAUTION

The wiring procedures in this manual are intended to ensure proper functioning of the device under normal conditions. However, because of the many variations in wiring codes and regulations, total compliance to these ordinances cannot be guaranteed. Be certain that all wiring complies with the NEC as well as all local ordinances. If in doubt, consult the authority having jurisdiction before wiring the system. Installation must be done by a properly trained person.

CAUTION

Observe precautions for handling electrostatic sensitive devices.

SAFEVADER Series Detector must be powered by a SELV power supply.

The SAFEVADER Series Detector shall be supplied by an isolated power source which fulfils the requirements of:

- Limited-Energy Circuit in accordance with UL/CSA 61010-1,
 - Limited Power Source (LPS) in accordance with (UL/CSA 60950-1 or EN 62368-1, Annex Q)
- or
- Class 2 supply source which complies with the National Electrical Code (NEC), NFPA 70, Clause 725.121 and Canadian Electrical Code (CEC), Part I, C22.1.

Prosense detectors can operate between 12 - 24 VDC. The detector designed to provide 4-20 mA current output signal. It is also possible to get voltage value via using an additional resistor. Table-4 gives recommended resistor specifications to get correct voltage output from detector depending of the desired signal level:

Detector Power VDC	Resistor	Signal level (4mA – 20mA)
12 VDC – 24 VDC	250 Ω, tolerance %1	1 VDC – 5 VDC
12 VDC – 24 VDC	500 Ω, tolerance %0,1	2 VDC – 10 VDC

Table 1: Detector power and the output resistor

Please consider the cable length when performing installation in the field. The Prosense detector requires a power supply between 12VDC and 24VDC. Make sure that a minimum 12 VDC supply available at the detector entrance and consider the voltage drop due to cable resistance in case of long distance applications. The maximum loop resistance in the field cable is calculated as follows:

$$R \text{ loop} = (V \text{ controller} - V \text{ detector min}) / I \text{ detector}$$

Example;

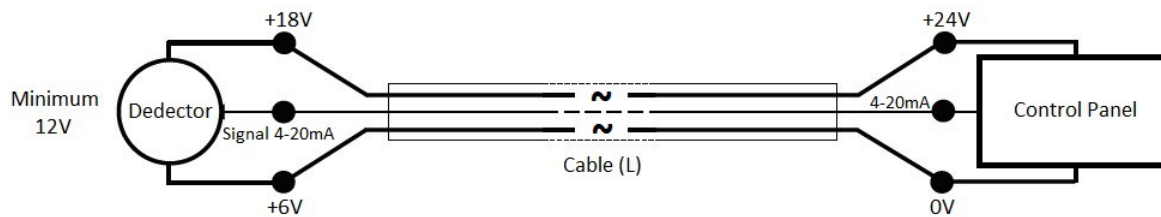

Diagram 4: Field cabling

The controller or power supply is supplying a nominal 24VDC (V controller), the detector minimum allowable voltage is 12VDC (V detector min), therefore the maximum allowable voltage drop between the controller and detector is 12VDC; this means a voltage drop of 6V in each core (V+ core and V- core).

Minimum power consumption of the detector without any optional module is 1W. The current required to drive the detector at the minimum voltage is

$$(I = P / V) : 1.0 / 12 = 85\text{mA (I detector)}.$$

Maximum power consumption of the detector when optional relay modules installed and all relays are active is 4.0W. The current required to drive the detector at the minimum voltage is $(I = P / V) : 4.0 / 12 = 335 \text{ mA (I detector)}$.

So, the maximum field cable loop resistance $(R \text{ loop}) = 12 / 0.335 = 36 \text{ Ohms}$, or 18 Ohms per core, (allowing for component variations, losses, etc.).

The following tables show the maximum cable distances between the controller and transmitter assuming a voltage drop of 6V in each core and for different cable parameters. The table values are examples only and actual cable parameters and source power supply voltage for the application should be used to calculate the maximum cable distance allowed at the installation site.

Typical cable data for detector with relay module given in Table 5:

Cable size (cross sectional area)	Cable type nearest equivalent	Cable resistance Ω/km	Maximum Cable length (L) Meters
0.5mm ²	20AWG	36.8 Ω/km	~400
1.0mm ²	17AWG	19.5 Ω/km	~700
1.5mm ²	16AWG	12.7 Ω/km	~1100
2.0mm ²	14AWG	10.1 Ω/km	~1400
2.5mm ²	13AWG	8.0 Ω/km	~1800

Table 2: Typical cable details and maximum distance for cabling

The use of industrial grade, suitably shielded field cable is recommended. Depending on the distance between signal received or control panel and detector 0.5 to 2.5 mm² (20 to 13 AWG) conductors can give better results. Ensure the cable gland is installed correctly and fully tightened.

Detector grounding

Internal Ground connection: Each detector has grounding screw which utilizes grounding for detector main PCB to detector body. The screw should be located correctly and fixed for all times. In case of any maintenance activity this screw should be checked and fixed to make sure for proper grounding.

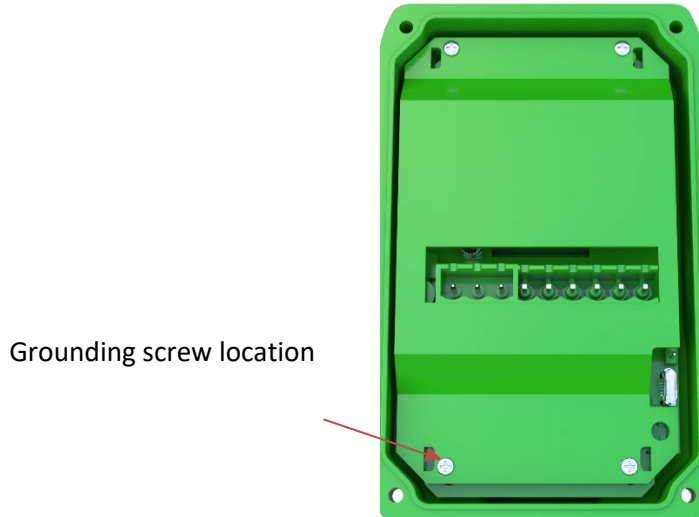

Diagram 5: Detector internal grounding screw location

Internal grounding screw location should be reserved for grounding cable and not used for any other purpose.



Minimum internal earth size must at least equal the incoming conductor size (i.e. 1.5mm² live/neutral = minimum of 1.5mm² earth too).

Cable and Earth/Ground regimes

Effective Earth/Ground bonding is important to ensure good EMC and RFI immunity. The following diagram show example of how to earth/ground bond the cable at enclosures. The same principles apply to conduit installations. These bonding techniques provide good RFI/EMC performance. Earth/ground loops must be avoided to prevent the risk of false signal variation.

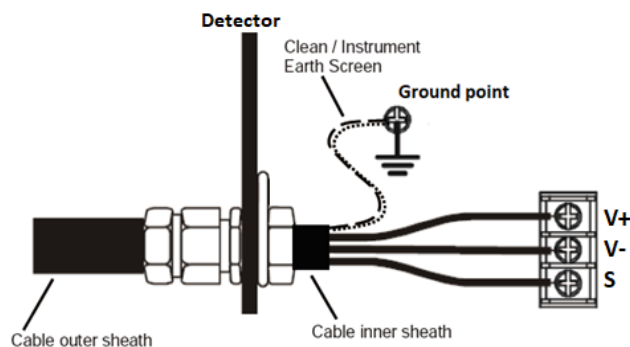

Diagram 6: Grounding

The Earth Screen of the field cable should be “tied to Earth” or connected to Ground at one point only. It is common practise to adopt a STAR EARTH connection regime where all instrumentation Screens are connected at one common point. The Screen at the other end of the cable should be “parked” or terminated into a blank terminal.

SafeVader Outputs

Prosense detectors preconfigured to provide signal from analogue and digital output depending on the detector and gas type. Detector Main board and connection details given in Diagram-11:



Diagram 7: Detector main board connections

Detector connections are listed in Table-6:

Port	Usage
V +	Power input (+) 12VDC – 28VDC
V-	Power input
S	Current Output Signal (4mA – 20mA)
A	RS485-A Serial connection port A
B	RS485-B Serial connection port B
C	Common COM port for All Relay outputs
F	Fault relay output
A1	Alarm-1 Relay output
A2	Alarm-2 Relay output

Table 3: Detector output ports and their usage

The Prosense SafeVader detector has 4-20mA analogue output, RS485 Modbus serial communication output and switching output features on main board. It is possible to use all outputs simultaneously.

4-20 mA output:

Prosense SafeVader detectors can be connected to control panels on the market having 4-20mA input signal. Signal wiring from detector and the control panel should be carried out by shielded cables. Wires cross section depends on the distance between the control panel and the detector. The details given in power cabling are valid for signal output as well.

Please avoid any interruption in case any junctions on wires. The shield is to be grounded from the control panel side only and never connect the shield to the detector. Please make sure clutching or crimping apparatus are not loosened or oxidized.

The analogue signal output levels can be adjusted in predefined range given below:

Status	Value/Setting	Default Setting
Fault	1 mA to 3 mA	2.0 mA
Warm-up	1 mA to 4 mA	3 mA
Calibration mode	1 mA to 4 mA	3mA
Normal gas measurement	4.0 mA to 20.0 mA	4.0 mA to 20.0 mA
Overrange	21.0 – 22.0 mA	22.0 mA

Table 4: Detector default configuration details

RS485 serial communication output:

Prosense SAFEVADER series detector has RS485 serial communication output on main board. User should prepare two wire additional cables when RS485 communication used. To use the detector with RS485 serial communication, a four-wire connection should be done which are energy input (V +, V-) ports and RS485 (A, B) ports. If both analog current output and RS485 serial communication terminals are to be used at the same time, a five-wire connection must be made to connect the terminals on both sockets (V +, V-, S, A, B). The total length of the connection line should not exceed 800 meters. The wiring for detectors utilized with RS485 board should be done by using connection cable EIA RS485 2 core wires with section 0.22 / 0.35 mm² and shielded. Nominal capacity between the wires should be < 50pF/m and nominal impedance 120 Ohms.

Detectors will be wired in daisy chain (bus) mode. We recommend not using star mode connection due to negative impact of interference. Each detector should have unique address number in the chain. The detectors would not be recognised by control panel if same address given to them. The address of detector can be adjusted via using display menu. Detectors can be assigned to use addresses from 1 to 247 (including 247). Address zero (0) cannot be used by detectors.

Relay Outputs:

Prosense SafeVader detectors have three relay outputs to generate switching output in case of Fault and defined level adjustable two alarms named as Alarm-1 and Alarm-2. The relay outputs set to NO (Normally Open – De-Energised) position at factory. All relays use same common port marked with C label and all common connections are shortcircuited.

The Fault relay is set to NO (Normally Open – Energised). It will be de-energized in case of power failure. This helps user to easily identify any power outage on detector side.

The alarm levels are also adjustable via using menu steps on display.

For oxygen detectors Alarm 1 Relay output predefined to alert Low level Oxygen status and Alarm 2 Relay output predefined to monitor High level Oxygen status.

System Status

The ProSense SafeVader detector has a screen to show status messages and measurement levels online. Also it has three LEDs to show power, fault and alarm status. If equipment is in normal condition the green power LED will blink with 1 second period and screen will show the gas that detector measuring, current level of gas detector measuring.



Diagram 8: SAFEVADER Series Detector Display and LEDs

Default display screen is used to show gas level as a text and bar graph, detector state and subsidiary messages such as fault, alarm 1 or overrange. The detector special state messages and related LED status for each special state are also shown;

SafeVader Series Visual Indications				
Status	Message	Power (Green)	Fault (Yellow)	Alarm (Red)
Power-on	Self Test	Flashing Green		
Warm-up	Warm-up	Flashing Green	Flashing Yellow	
Normal	Normal	Flashing Green		
Fault	Fault	Flashing Green	Solid Yellow	
Calibration	Calibration	Flashing Green	Flashing Yellow	
Underrange	Fault	Flashing Green	Solid Yellow	
Alarm 1	Alarm 1	Flashing Green		Solid Red
Alarm 2	Alarm 2	Flashing Green		Solid Red
Overrange	Overrange	Flashing Green	Flashing Yellow	Solid Red

Table4: SafeVader Series visual indications

Indication of measured values

Display screen shows the concentration level of the target gas in two ways. In the first, a numeric value is shown in the middle of the display in the units selected (PPM, %LEL, %VOL). The second concentration display is shown in the form of a bar graph representing the current concentration against full scale and in relation to the defined alarm levels.

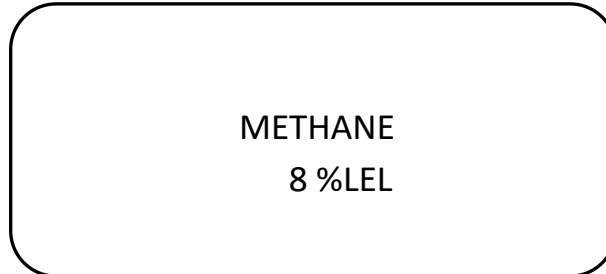

Warmup

The detector will need to warm-up to be ready when power applied. Warm-Up period takes 1-2 minutes depending on the sensor and during this time WARMUP status messages shown on upper right side of the screen. Also Fault LED will be lit.

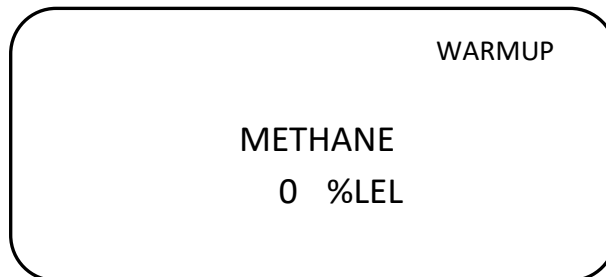

User must wait till end of the warm-up period to see actual status of the detector.

Fault

If detector is in fault condition Fault LED will be lit, screen show fault message and the detector analogue output gives 2mA on S port. If detector could not get enough power (lower than 12 VDC) it will also raise fault status.

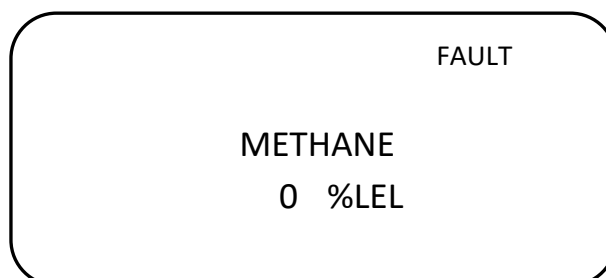

Detector also provides key information about fault reason and details. They are listed at Fault status codes section.

Alarm

Equipment has LED indication on the display module for alarm levels which are Alarm-1, Alarm-2 and Alarm-3. The Alarm-1 and Alarm-2 is integrated to relay module and equipment can

provide switching output for defined alarm levels. Alarm-3 is only visual alarm and it is not integrated to relay module. Hence it is not possible to get switching output for Alarm-3. In case of an alarm, related alarm LED will lit and alarm information will be shown on the screen:

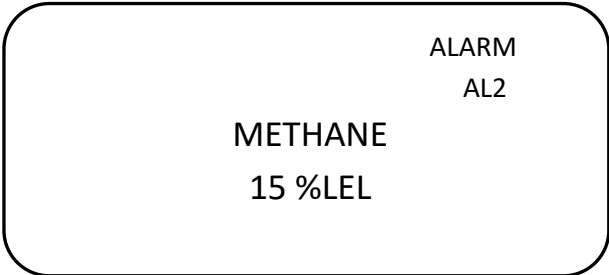

Calibration

Equipment shows countdown messages during the calibration. Equipment shows calibration message on display only in case user exited from menu during the calibration:

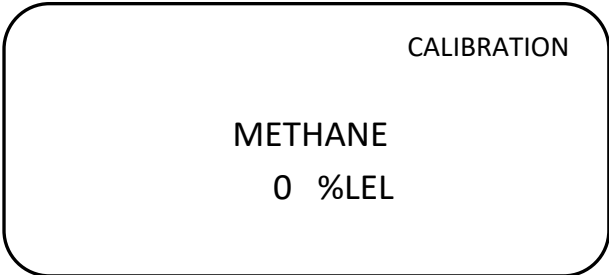

Underrange

Equipment detects underrange condition and set fault state where Fault LED will be lit, screen show fault message and the detector analogue output gives 2mA.

Overrange

Equipment provides overrange condition in case the measured gas level over the measurement range. All Alarm LEDs and Fault LED will be lit, screen show Overrange message and the detector analogue output gives 22mA. Overrange status on RS485 MODBUS output. If relay module is installed all relays Fault, Alarm-1 and Alarm-2 will be activated. The status will not change without user intervention even the gas concentration returns to normal level. It is necessary to power-cycle detector to reset status by user intervention.

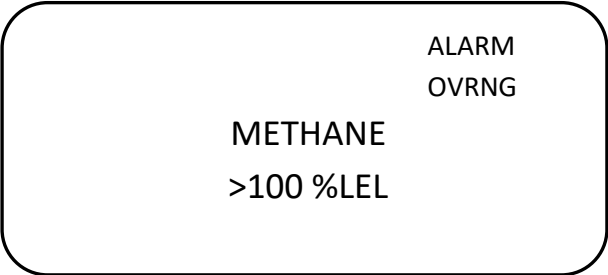

When user reset detector after environmental conditions return to normal, detector will perform all self-test and hardware test steps following reset. User can see detector status after reset. If detector returns to normal no additional step is required.

Analogue Output State:

Analogue output of equipment provides state information to external devices via current level. The output provides signal between 0- 22mA:

- Equipment provides meaningful measurement level between 4-20mA current level. The external device must evaluate 4-20mA current level as measurement level information. The evaluation of measurement level regarding a dangerous gas concentration must be performed by an external device.
- Equipment provides 0-2mA current level when it detects any internal error. The external device must evaluate 0-2mA current level as fault condition.
- Equipment provides 20-22mA current level as overrange state indication. The external device must evaluate 20-22mA current level as overrange condition which is a dangerous gas concentration.

State details and indications are given in below tables:

SAFEVADER Analogue output states and indications

Signal	Meaning	Output(mA)	Power LED	Fault LED	Alarm LED	Display
Warm-up	Device is working and waiting for sensor stabilization after power-on. Actual measurement level is not used to provide measurement result or alarm generation.	3	blinking	blinking	off	Warm-up
Fault	Device is in fault condition, not performing measurement	<2	blinking	solid	off	Fault
Calibration	Device is working and performing calibration for sensor. Actual measurement level is not used to provide measurement result or alarm generation.	3	blinking	blinking	off	Calibration
Normal	Device is performing measurement	4-20	blinking	off	off	Measurement level
Alarm	Measured gas level is higher than defined alarm level	4-20	blinking	off	on	Alarm
Overrange	Measured gas level is higher than measurement range	20-22	blinking	blinking	on	Overrange
Underrange	Measured gas level is deviated from the minimum allowed level	<2	blinking	solid	off	Fault

Table 5: SAFEVADER Analogue output states and indications

Switching Output State

In normal operation fault relay is in switched off position, only when the fault relay coil is energized (contact closed) are the output states valid. The evaluation of the fault relay must be performed by an external device.

Alarm Relay-1

Indicate if the measured concentration of gas is greater than alarm 1 on-threshold by energising the first normally energised alarm relay, with the relay response following the calculated gas level with a delay of no more than 5 second.

Alarm Relay-2

Indicate if the measured concentration of gas is greater than alarm 2 on-threshold by energising the second normally energised alarm relay, with the relay response following the calculated gas level with a delay of no more than 5 second.

Fault relay output

Fault relay should be designed as closed circuit / de-energise to trip principle and provide device state information. As it is a switching output it has two states and behaves as given in below table:

Status	Output(mA)	Fault Relay		Alarm 1 Relay		Alarm 2 Relay	
		Energy (Coil)	Circuit (Out)	Energy (Coil)	Circuit (Out)	Energy (Coil)	Circuit (Out)
Power-off	0	De-energized	Contact close	De-energized	Contact open	De-energized	Contact open
Warm-up	3	De-energized	Contact close	De-energized	Contact open	De-energized	Contact open
Fault	2	De-energized	Contact open	De-energized	Contact open	De-energized	Contact open
Calibration	3	De-energized	Contact close	De-energized	Contact open	De-energized	Contact open
Zero gas	4	Energized	Contact open	De-energized	Contact open	De-energized	Contact open
Alarm-1 level	Adjustable	Energized	Contact open	Energized	Contact close	De-energized	Contact open
Alarm-2 level	Adjustable	Energized	Contact open	Energized	Contact close	Energized	Contact close
Full Scale Gas	20	Energized	Contact open	Energized	Contact close	Energized	Contact close
Over-range	22	Energized	Contact close	Energized	Contact close	Energized	Contact close
Under-range	2	De-energized	Contact close	De-energized	Contact open	De-energized	Contact open

Table 6: SAFEVADER Series Switching output states and indications

Other than given states the detector is working fine and fault relay will be energised and relay contact will be open circuit.

Commissioning

WARNING

The following procedure requires the detector cover to be removed while carrying out supply voltage checks. Therefore, the appropriate permits to work should be sought in preparation.

Prior to carrying out any HOT WORK ensure local security and site procedures are followed. Ensure that the associated control panel output actuation is inhibited so as to prevent false alarms.

Caution: The following procedure should be followed carefully and only performed by suitably trained personnel

Commissioning SafeVader

1. Remove the detector cover. Gently remove the front panel and PCB with cover from detector base.
2. Configure the detector's analogue output signal and power input connections correctly
3. Check that all electrical connections are terminated correctly
4. Switch On the external power supply to feed the detector
5. Using a Digital Multi Meter (DMM), check the Supply Voltage at the terminals V+ (24V) and V- (0V), this should be a minimum supply voltage of 12VDC (Maximum supply voltage is 24VDC)
6. Check LED status on detector main board. LED will be illuminated right after applying power.
7. Check the screen. It will run self check tests and report the results. All tests should end with OK. In case of any ERROR message contact Prosense.
8. When test completed the screen will show monitoring screen with detector information and WARMUP message on status line. The Fault LED is lit in this period.
9. Wait two minutes to see WARMUP message removed from status line and fault LED gone off.
10. Switch Off the external power to the detector.
11. Fix the front panel and main PCB to detector base via securely locating the cables. Fix the front panel screws.
12. Switch on external power to the detector.

Detector Settings

Prosense SAFEVADER detector prepared at factory to work as standalone detector. User may want to change settings and alarm levels depending of the requirements. SAFEVADER detector screen can be used to change the detector settings. There are 3 buttons on display to perform menu operations which are Enter, up (Increase) and down (decrease). If user wants to cancel any operation on any screen keep pressing on Enter key till the screen return back to previous screen.

Entering the menu:

To reach configuration menu press Enter. The screen will request password information:

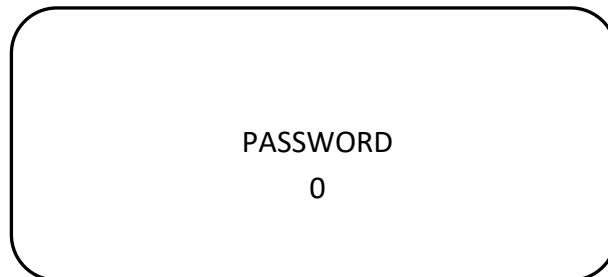

The password is 1234. User need to change the password as defined in “Change password” step. You need to set values via using up and down keys. Once the value is set press Enter again to confirm and move to the next digit. Confirmed digits will be made invisible by detector program:



The screen will display menu options when correct password entered at last digit:

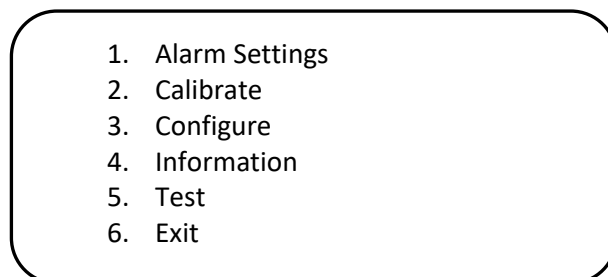

Menu structure

SAFEVADER Series Detector menu includes all necessary steps to setup detector and display information.

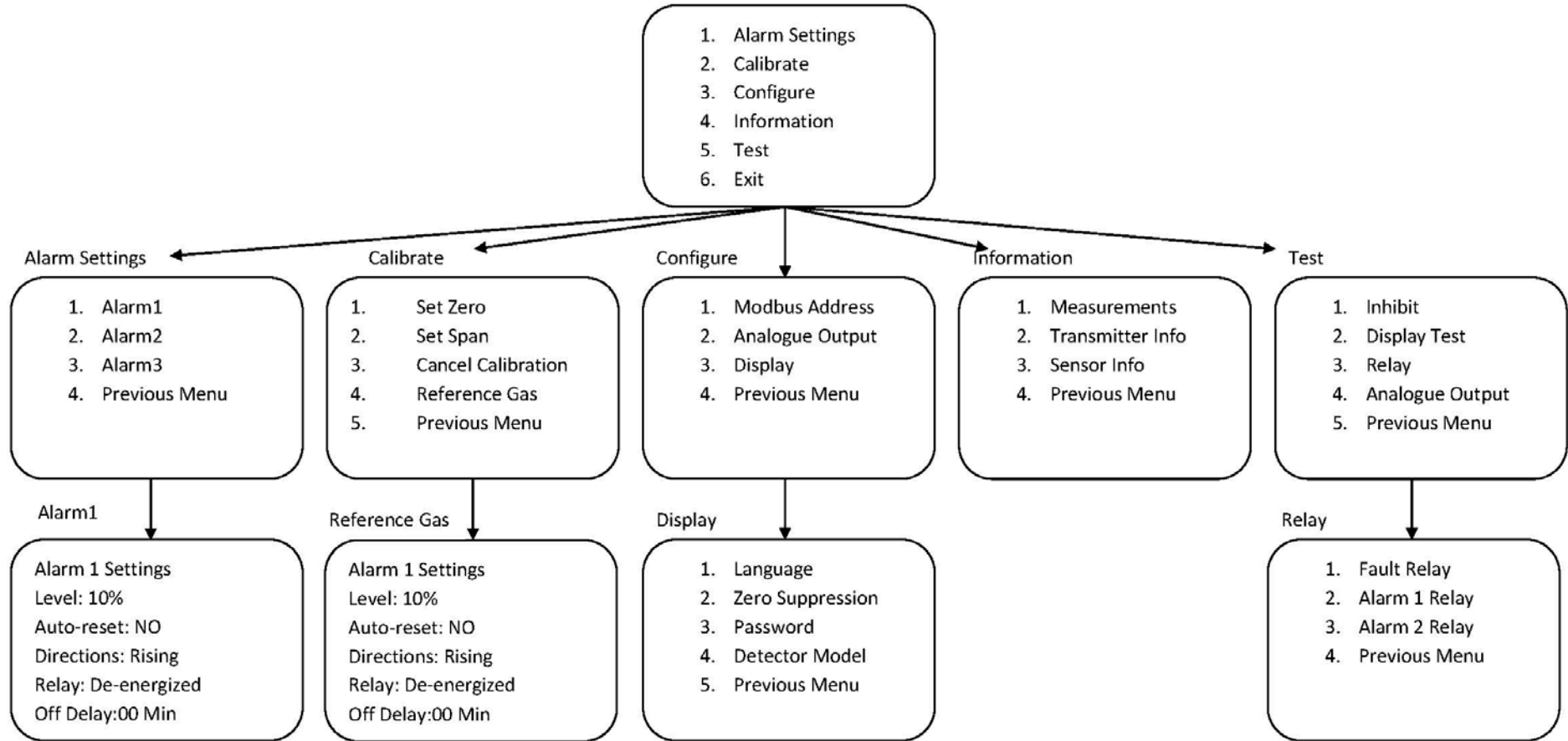
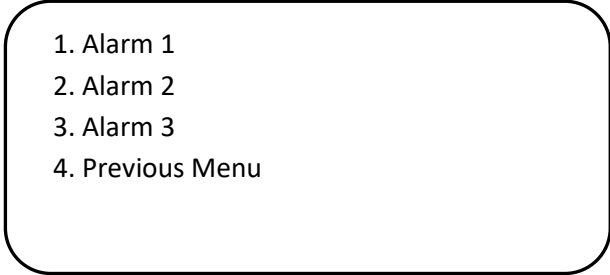

Diagram 9: Main menu structure

Alarm Settings

Alarm levels can be adjusted via using alarm menu steps. Once you reach the main menu the first option is alarm settings. Press Enter to move the alarm settings menu. A new menu listing alarm levels will be shown:

- 
1. Alarm 1
 2. Alarm 2
 3. Alarm 3
 4. Previous Menu

Please select the alarm level you would like to adjust and press Enter key to see details. All alarm details will be listed in new screen and parameters will be blinking one by one while you set the values.

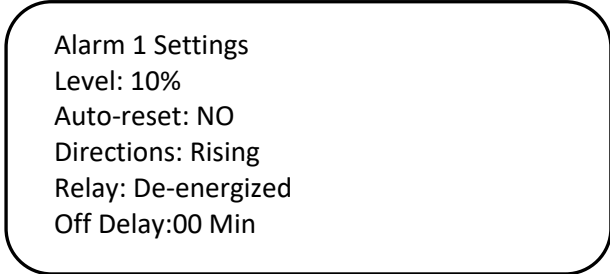

Alarm 1 Settings
Level: 10%
Auto-reset: NO
Directions: Rising
Relay: De-energized
Off Delay: 00 Min

The first digit of the first alarm will start blinking to let you increase or decrease the digit via using up and down keys. When you set the value, press again Enter key to move next digit. The next digit will start blinking to allow you set desired value. When you complete, press Enter key long enough. The display will show "Successful" message and return back to higher level menu. All alarm levels have same parameter that user can adjust if needed. Otherwise, they will work with their default settings. The meaning of parameters is as follows:

Level: The measurement level to raise the alarm

Auto-reset: Define how the alarm relays will work. If 'YES' selected the relay will be released once the measurement level returned to normal. If 'NO' selected the relay will lock in their position. According to IEC EN 60079-29-1 highest level alarm "Alarm-2" is set to latch mode without auto-reset.

Directions: Parameter to define in which way alarm will be activated whether increasing or decreasing. For most toxic and flammable gases it will be raising, for oxygen it can be both raising and falling.

Relay: It defines the alarm relay working conditions. Relays can be programmed as Energised (NC) or Non-energized (NO) contact according to use cases and scenarios. When Energized is selected, the relay will have energy during normal operation. When Non-energized is selected, the relay is only energized when performing the switching function.

Off Delay: User can define delay to deactivate the alarms. Equipment keeps alarms and relay contacts active after measured gas level goes below the defined alarm level. This function must be adjusted according to operating conditions and safety rules. For example, in a plant

ventilation fan kept activated after the measurement level falls below the alarm level. In such cases the off-delay feature can be used. The off-delay can only be defined in minutes.

Configure

User can change the parameters of detector depending of the usage such as date, time, password and detector address via configure menu. Select 'Configure' step on main menu to perform changes. A new menu options will display with options:

- 1. Modbus Address
- 2. Analog Output
- 3. Display
- 4. Previous Menu

Change Modbus address

To change detector address, select "Modbus Address" menu option. In RS485 communication detectors are slave devices and control panel is the master device. Each detector must have unique address to work together in same RS485 communication loop. Select "Modbus Address" menu item via using up and down keys and press Enter key. Display will show default detector address which is 1:

Slave Address: 1
RS485 Connected: YES

Address can be changed with up and down keys from 1 to 256. Once set to desired address press Enter key long enough. The display will show "Successful" message and return back to higher level menu.

Change Analogue Output

User can adjust analogue output levels depending of the status and function. To do this please select "Analogue Output" menu item on configuration menu via using up and down keys and select Enter key. Screen will display default values used for analogue output:

4-20mA Output

Fault	: 2.0 mA
Warm Up	: 3.0 mA
Calibration	: 3.0 mA
Inhibit	: 3.0 mA
Over Range	: 22.0 mA

User can adjust these values to desired values depending of the application requirements between 1 to 3.5 mA for Fault, Warm-up, Calibration, Inhibit and 20-22mA for Overrange.

Display Parameters

Detector display can be adjusted as per requirements. The display options are given in Display menu item

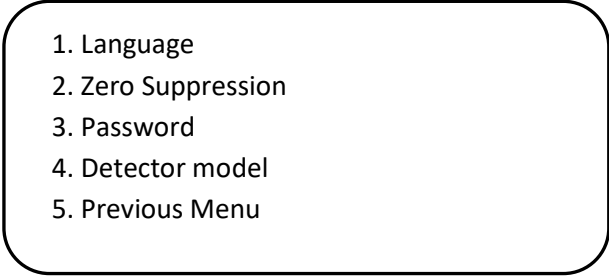
- 
1. Language
 2. Zero Suppression
 3. Password
 4. Detector model
 5. Previous Menu

Change Language

The detector display language can be changed to English or Turkish. To change Language first select Configure option on main menu then select Display option and Language option. Once you reach to Language screen you will able to switch display language:

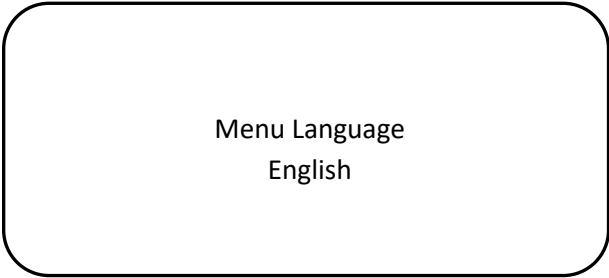

Menu Language
English

Change Zero Suppression

User can adjust the way showing measurement level around zero level. If zero suppression mode set to NO, detector will display measurement as detected. If zero suppression mode set to YES, detector will show measurement levels as 0 (zero) up to 3% LEL. At 3% LEL it will display measurements as detected.

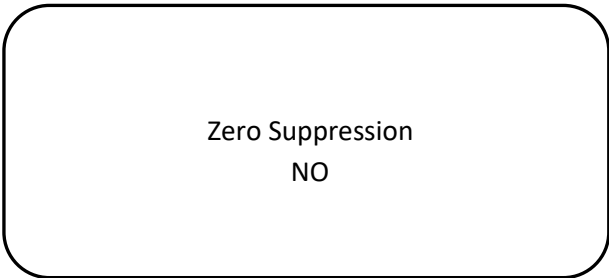

Zero Suppression
NO

To change zero suppression mode select Zero Suppression option on Display menu and pres Enter key. Current zero suppression mode will be displayed. If needed change the value via using up and down keys. Once adjusted press Enter key to record value.

Change password

User must change the default password for security reasons. The default password is 1234. To change password select Password menu item via using up and down keys and press Enter key.

Display will ask new password:

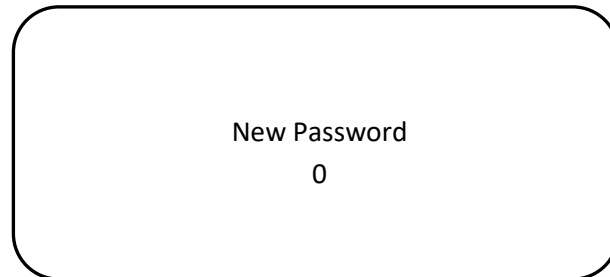

New Password
0

Password must be 4 digits and should be set digit by digit via using up and down keys. When completed, press Enter key long enough to confirm. The display will show “Successful” message and return back to higher level menu. User should remember the password to perform changes later on. If user forgets the password, detector should be returned back to Prosense to reset password. No Field operation is available to reset password at customer site.

Information Menu options

Information menu provides more detailed information about measurements and device itself. The Information menu steps are given in below diagram:

1. Measurements
2. Transmitter Info
3. Sensor Info
4. Previous Menu

Display Measurements

To get more details about the measurements please select measurements option in Information menu. Detector will display the voltage, current and temperature levels as in below example:

```
Input Vol.      :23.3V
Sensor Vol.     :2506mV
Sensor ADC      :504
Current Output  :4mA
Line Res.       :206 Ohm
Temperature     :34C
```

Display Transmitter information

To get details about transmitter and firmware level use transmitter information step in Information menu. A screen will display details.

```
Prosense Ltd. KS031
XMTR S/N:00021907
XMTR F/W:V.1.1.0
DSP F/W :V.1.1.1
Modbus Adr.:01
Test Due:18/12/2018
```

To return back to previous menu please press Enter key till the screen changes.

Display Sensor information

To get details about transmitter and firmware level use transmitter information step in Information menu. A screen will display details.

```
100%LEL METHANE
S/N:21A06583
Alarm 1:10
Alarm 2:15
Alarm 3:20
Cal. Due:18/09/2019
```

To return back to previous menu please press Enter key till the screen changes.

Test Menu Options

User can execute tests to check detectors functions. To perform tests select Test menu item via up and down keys then press Enter key. The screen will display test options:

1. Inhibit
2. Display
3. Relay
4. Analog Output
6. Previous Menu

To execute tests select desired test option and press Enter key. To return back to previous menu please select Previous Menu option and press Enter key.

Run Inhibit test

User can initiate detector to work in inhibited mode. In this mode detector will provide the signal level defined in configuration details for inhibited mode (default is 3mA) and the alarms will be deactivated. When Inhibit option selected in Test menu below screen will display to set inhibit detector:

1. Set
2. Previous Menu

If user finish the work or test it is necessary to clear inhibit mode to return detector to normal operation. To do this user should re-enter to Inhibit menu in Test menu. The clear option will be displayed at this time:

1. Clear
2. Previous Menu

Run Display test

To execute display tests select Display option on Test menu and press Enter key. The detector program will start display test via drawing different patterns. It might take one minute to complete test. The display will return back to Test menu when test completed.

Run Relay test

It is possible to check relay functions via using menu options. Relays are only available if optional relay module installed on to detector main board. To run relay test please select test menu and

select Relay option. Screen will display three options to test as there are three relays on relay module. Select the menu option related to desired relay test and press Enter key.

- 1. Fault Relay
- 2. Alarm 1 Relay
- 3. Alarm 2 Relay
- 4. Previous Menu

If fault relay test selected, detector will activate the relay and screen will display information:

Fault Relay
is active

If alarm relay selected, detector will activate related alarm relay and screen will display information:

Alarm 1 Relay
is active

To return back to previous screen please press Enter key till the screen updated with previous menu items.

Run Analogue Output test

To test analogue output level user can initiate the analogue output test in Test menu. Once Analogue Output option selected press Enter Key. Screen will display the analogue output level. User can increase or decrease the output signal level via using up and down keys.

Analog Output
02.0 mA

To return back from Analogue Output test please press Enter key till the screen updated with previous menu items.

Calibration

It is recommended to periodically carry out calibration to ensure correct operation. Prosense SAFEVADER series detector calibration includes two steps as zero and span calibration. It is possible to perform each step independently. Prosense recommends to perform both calibration steps to have correct calibration. Detector should be powered and stabilized for at least 4 hours before calibration. During the calibration phases the detector output is inhibited (default 3mA) to avoid false alarms. Zero calibration of infrared sensors should be done with N2 and zero calibration of other sensors should be done with zero air (O2 and N2 gas mixtures). It is possible to use calibration gas from 25%LEL to 75%LEL gas concentrations via adjusting reference gas details on detector menu for calibrating flammable gas detectors It is necessary to use international tracable gases.

To calibrate the detector, use an appropriate span gas cylinder, constant flow regulator and Prosense Gas Cap. The gas flow rate must be 0,5lt/min for correct calibration.

It is recommended to use a compressed air cylinder (20.9%Vol oxygen) to perform the zero calibration if the area where the detector is located contains any residual amount of the target gas. If no residual gas is present then the background air can be used to perform the zero calibration.

To perform calibration procedure a hand terminal or screen is necessary. Attach hand terminal to detector and press Enter to reach menu. The screen will request password information:

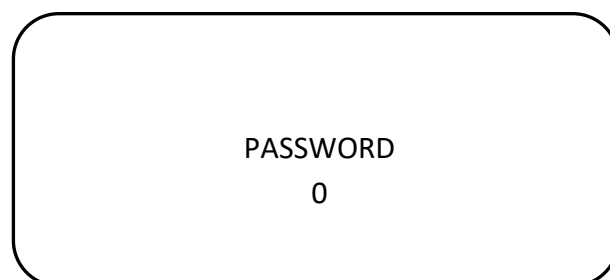

The default password is **1234**. If user changed the default password use updated password. You need to set values via using up and down keys. Once the value is set press Enter again to confirm and move to the next digit. The digit confirmed will made invisible by detector program:



If the password is wrong the display will return to measurement screen. The screen will display menu options when correct password entered at last digit:

- 1. Alarm Settings
- 2. Calibrate
- 3. Configure
- 4. Information
- 5. Test
- 6. Exit

Select Calibration. Screen will show calibration options:

- 1. Set Zero
- 2. Set Span
- 3. Cancel Cal
- 4. Reference Gas
- 5. Cal. Interval
- 6. Previous Menu

It would be better to first set reference gas details and calibration cycle period as these values cannot be altered once calibration started for zero or span. Zero or Span calibration can be performed separately at any time. It is recommended to perform Zero calibration first and perform Span calibration following zero calibration completion.

Set Reference Gas details

During calibration technician should use a certificated specific gas. The details of the gas should be entered before starting the calibration. Otherwise detector program will use default values entered at factory. If the calibration gas is different than default gas specifications the calibration will fail or will be wrong. Select fourth item 'Reference Gas' on calibration menu to set details of the gas you will use during calibration. The default value is % 30 LEL will be displayed:

Reference Gas
Conct.: 030 %LEL
Type: METHANE

The first digit will start blinking on screen. You can change the value of each digit with up and down keys. Once set, confirm value with Enter key and move to the next digit.

Zero Calibration

Select Set Zero option on calibration menu and press Enter key to start zero calibration. Program will request a confirmation to start zero calibration:

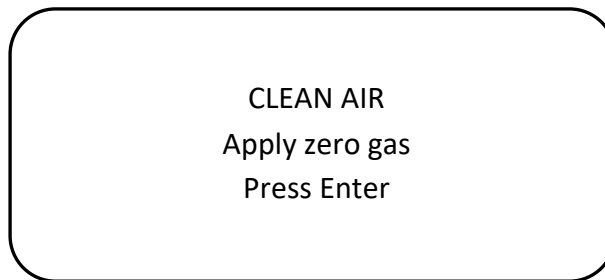

When entered it will start countdown from 60 to 0:

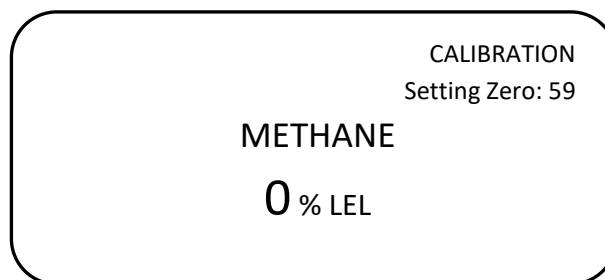

During 60 seconds you should apply necessary gas for zero level. For catalytic, pellistor and electrochemical sensors use clean air gas, for infrared sensors use N2 gas. For more details contact Prosense. Detector will automatically perform zero calibration while gas applied to sensor during this period.

Span Calibration

To perform Span calibration Select Set Span option on calibration menu and press Enter key to start span calibration. At same time prepare the span gas cylinder and regulator; mount the calibration adaptor to the sensor head and apply gas to the detector. Program will request a confirmation to start Span calibration:

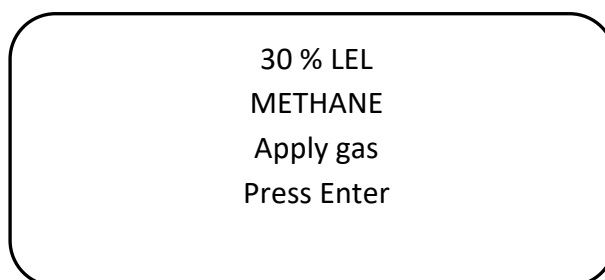

After pressing Enter key screen will again show countdown:

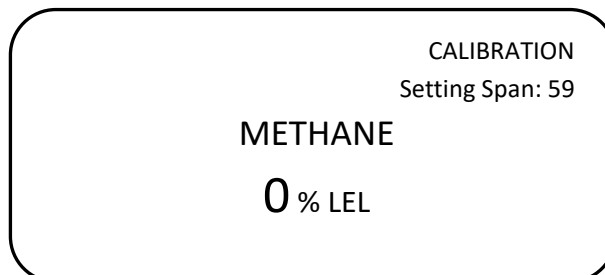

Span period may vary depending of target gas. Span gas should be applied to sensor during span period. Detector will automatically set span level. When the countdown is complete, the detector exits the menu steps and returns measurement screen but stays in calibration mode. In this case, the value is read on the screen as gas is applied to the detector. However, the detector does not generate an alarm because the detector is in calibration mode. After the calibration is completed, the detector continues to operate in calibration mode until the amount of gas detected falls below the value defined for alarm1 and the message "CALIBRATION" is displayed on the screen. When the amount of gas detected after the calibration falls below the alarm1 level, the detector switches to the normal operating mode from the calibration mode. The detector stays in calibration mode for up to 5 minutes and returns to normal operating mode. If the gas level does not decrease for 5 minutes after the calibration, the detector starts to generate an alarm.

Cancel Calibration

Calibration can be cancelled anytime during calibration operation. If user thinks something done wrong by mistake, should select "Cancel Cal" option on calibration menu. Detector will ask confirmation to cancel:



Press Enter key to cancel calibration operation.

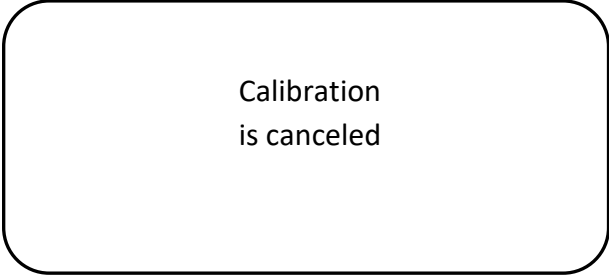

Detector will erase the values recorded during calibration steps and uses previously recorded calibration levels.

Maintenance



CAUTION

The detector contains no user serviceable components. Service or repair should never be attempted by the user. Device repair should be performed only by the manufacturer or trained service personnel.

LIABILITIES

The manufacturer's warranty for this product is void, and all liability for proper function of the detector is irrevocably transferred to the owner or operator in the event that the device is serviced or repaired by personnel not employed or authorized by Prosense, or if the device is used in a manner not conforming to its intended use.

Proactive maintenance:

All gas detectors including both for flammable and toxic gases should have to pass a functional test and calibration every three to twelve months according to EN 60079-29-2 industrial standards. The test results and calibration reports should be recorded in maintenance books.

Operational Life:

Typical operational life time is 10 years and it depends on conditions equipment used and below sensing element details.

Catalytic flammable gas sensor made by using the pellistors that suffer from a loss of sensitivity when in the presence of poisons or inhibitors, e.g. silicones, sulphides, chlorine, lead or halogenated hydrocarbons. The pellistors are poison resistant to maximize the operational life of the Catalytic flammable sensor. A typical operating life, subject to the presence of poisons/inhibitors is 48-60 months.

The infrared flammable gas sensor is not affected by the mentioned poisons and has a longer life span around 5 years.

Typical life of a toxic gas sensor which made by electrochemical component is dependent on the application, frequency and amount of gas exposure. Under normal conditions (visual inspection in 3 months period and test/recalibration in 6 months period), the Prosense Oxygen and other toxic sensors have an expected life equal to or greater than 24 months.

Sensor module replacement:

The sensors are mounted to sensor electronic module inside the detector enclosure cover and it is possible to perform replacement in the field. Once replacement sensor on hand follow the steps given below:

- 1- Power-off the detector via disconnecting power cable from control panel or supply
- 2- Use screwdriver to remove 4 screws on front panel
- 3- Remove front panel from enclosure body
- 4- Use screwdriver to remove screws from PCB holder
- 5- Remove enclosure cover.
- 6- Remove sensor module from main PCB connectors.

- 7- Install the new sensor module in to main PCB connectors.
- 8- Check and replace the filter located on enclosure cover if necessary.
- 9- Fix main pcb to enclosure cover.
- 10- Fix front panel to enclosure body.
- 11- Power On and check status.
- 12- The sensor module has been calibrated at Prosense factory and calibration parametrs are recorded. But if you see any deviation perform full calibration at least 4 hours later or next day.

Detector Transmitter board replacement:

Prosense detector transmitter is the main logic board including all definitions and configuration. Hence it is necessary to perform reconfiguration in case of replacement. Hence the spare part must be ordered by giving the serial number of the detector. The replacement should be done via following steps:

- 1- Power-off the detector via disconnecting power cable from control panel or supply
- 2- Use screwdriver to remove 4 screws on front panel
- 3- Remove front panel from enclosure body
- 4- Use screwdriver to remove screws from PCB holder
- 5- Remove enclosure cover.
- 6- Remove sensor module from main PCB connectors.
- 7- Remove all cable connectors from terminals.
- 8- Remove main PCB from PCB holder via releasing the latches.
- 9- Install the new main PCB to PCB holder via fixing the latches on holder.
- 10- Install sensor module in to sensor connections on main PCB.
- 11- Check and replace the filter located on enclosure cover if necessary.
- 12- Fix main pcb to enclosure cover.
- 13- Fix front panel to enclosure body.
- 14- Power On and check status.
- 15- The main PCB module parameters recorded at Prosense factory. But if you see any deviation perform full parameter adjustment and calibration if necessary at least 4 hours later or nex day.

Display Module replacement:

Prosense display board is a replaceable part. The replacement should be done via following steps:

- 1- Power-off the detector via disconnecting power cable from control panel or supply
- 2- Use screwdriver to remove 4 screws on front panel
- 3- Remove front panel from enclosure body
- 4- Use screwdriver to remove screws from PCB holder
- 5- Remove enclosure cover.
- 6- Remove sensor module from main PCB connectors.
- 7- Remove all cable connectors from terminals.

- 8- Remove main PCB from PCB holder via releasing the latches.
- 9- Remove Display module cable from main PCB via unlatching the connector.
- 10- Safely locate the display cable in to main hole located on main PCB.
- 11- Install new display module cable to main PCB display connector.
- 12- Install sensor module in to sensor connections on main PCB.
- 13- Fix main pcb to enclosure cover.
- 14- Fix front panel to enclosure body.
- 15- Power On and check status.

Fault Status Codes:

Fault Message	Fault Description
SENSOR	Sensor is in fault condition
ADC	ADC circuit is not functioning correctly
CURRENT	Detector is not generating analogue output signal
POWER	Power input is out of range
CPU RAM	RAM fault detected
CPU FLASH	Flash error detected
EEPROM	EEPROM error detected
CAL DUE	Defined calibration period is passed, calibraton needed
RS485	RS485 communication failure
CPU	CPU failure
TEST DUE	Defined test period is passed, test execution needed
LINE	Analogue output is not connected or shortcircuited
TEMPERATURE	Sensor temperature error
NO COMM	Display communication failure

Table 7: SAFEVADER Series Fault Status Codes

General specification

Electrical Specifications:

Detector must be powered by a SELV power supply.

Power Input	12 to 28VDC (24VDC nominal)
Max Power	Max 4 Watts. at 24VDC
Current output	1-22mA
Fault	1.0 - 3.5 mA (adjustable)
Warm-Up	1.0 - 3.5 mA (adjustable)
Inhibit	1.0 - 3.5 mA (adjustable)
Calibration mode	1.0 - 3.5 mA (adjustable)
Normal gas measurement	4.0 mA to 20.0 mA
Over range	20.0 - 22.0 mA (adjustable)
Under range	Fault signal (1.0 - 3.5 mA - adjustable)
Terminals	3 x screw terminals suitable for wire diameter 0.5 mm ² to 2.5 mm ² (20AWG to 13AWG). Use Copper Conductors Only!
	2 x screw terminals suitable for wire diameter 0.5 mm ² to 2.5 mm ² (20AWG to 13AWG) for RS485 digital output. Use Copper Conductors Only!
Relays	3 x (1.25A 30VDC).
Communication	RS485, Modbus RTU

Table 8: Electrical specifications

Detector Body Specifications:

Material	ABS Plastic
Weight	300gr
Mounting	Wall mounting
Entries	2 x PG9

Table 9: Detector body specifications

Environmental:

IP Rating	IP65 in accordance with EN60529:1992
Operating Temperature	-20°C to +60°C / -4°F to +140°F
Operating Humidity	Continuous 20-90%RH (non condensing)
Operating Pressure	80-120kPa
Storage Conditions	5°C to +25°C Detectors must be re-calibrated if not installed more than 3 months
Operating Altitude	0-2500m
Use	Indoor

Table 10: Environmental specifications

Default Configuration:

Function	Value/Setting	Meaning
Sensor Type	Automatic detection	SAFEVADER automatically detect the sensor
Signal output	2mA (1.0 - 3.5 mA adjustable)	Fault
	3mA (1.0 - 3.5 mA adjustable)	Warm-Up
	3mA (1.0 – 4.0 mA adjustable)	Inhibit
	3mA (1.0 – 4.0 mA adjustable)	Calibration mode
	4.0 mA to 20.0 mA	Normal gas measurement
	22mA (20.0 - 22.0 mA adjustable)	Over range
	2mA (1.0 - 3.5 mA - adjustable)	Under range (Fault)
Alarm Relay 1*	Value is sensor dependant	Lower alarm level
	De-energized	Energizes on alarm
	Contact Normally Open (NO)	Closes on alarm
Alarm Relay 2*	Value is sensor dependant	Higher alarm level
	De-energized	Energizes on alarm
	Contact Normally Open (NO)	Closes on alarm
Fault Relay	Value is sensor dependant	Detector Fault
	Energized	De-energizes on alarm
	Contact Normally Open (NO)	Closes on alarm
Password	1234	password to menu access

Table 11: SAFEVADER Series default Configuration

Detector Default Alarm Settings					
Gas Name	Range	Lower Alarm	Lower Alarm Type	Higher Alarm	Higher Alarm Type
Oxygen	25.0%vol	19%Vol	Falling	23%vol	Rising
Toxic	1-1000ppm	%10 of FS	Rising	%15 of FS	Rising
VOC	100-1000ppm	%10 of FS	Rising	%15 of FS	Rising
Refrigerant gases	2000-10000ppm	%10 of FS	Rising	%15 of FS	Rising
Flammable	100%LEL	10%LEL	Rising	15%LEL	Rising
Carbon Dioxide	5%Vol	1%Vol	Rising	2%Vol	Rising
	5000ppm	2000ppm	Rising	3000ppm	Rising

Table 12: SAFEVADER Series default alarm settings

Warranty statement

All products are designed and manufactured to the latest internationally recognized standards by Prosense under a Quality Management system that is ISO 9001 certified. As such Prosense warrants its products against defective parts and workmanship and will repair or (at its option) replace any instruments which are or may become defective under proper use within 12 months from date of shipment from Prosense Technology. The Product will be returned repaired or replaced if it is determined by Prosense that the part failed due to defective materials or workmanship. Warrant is only valid if product is shipped prepaid to Prosense at Kartal, Istanbul TURKEY, in a package equal to or in the original container accompanied by a detailed description of any issue. Prosense reserves the right to charge for any site attendance where any fault is not found with the equipment in case return of goods is not practicable. Prosense shall not be liable for any loss or damage whatsoever or howsoever occasioned which may be a direct or indirect result of the use or operation of the Contract Goods by the Buyer or any Party.

This warranty covers instrument and parts sold to the Buyer only by authorized distributors, dealers and representatives as appointed by Prosense Technology. The warranties set out in this clause are not pro rata, i.e. the initial warranty period is not extended by virtue of any works carried out there under.

Exclusions

If gas sensors are part of the Product, the gas sensor is covered by a twelve (12) month limited warranty of the manufacturer. The gas sensors are covered by this limited warranty is subject to inspection by Prosense for extended exposure to excessive gas concentrations if a claim by the user is made under this limited warranty. Should such inspection indicate that the gas sensor has been expended rather than failed prematurely, this limited warranty shall not apply to the Product.

This limited warranty does not cover consumable items, such as batteries, or items subject to wear or periodic replacement, including lamps, fuses, valves, vanes, sensor elements, cartridges, sinters or filter elements. This warranty does not cover damage caused by accident, abuse, abnormal operating conditions or poisoning of sensor.

Warranty Limitation and Exclusion

Prosense will have no further obligation under this limited warranty. All warranty obligations of Prosense are void in below cases:

- if the Product has been subject to abuse, misuse, negligence, or accident
- if the Distributor or User fails to perform any of the duties set forth in this limited warranty
- if the Product has not been operated in accordance with instructions
- if the Product serial number has been removed or altered

Limitation of Liability

In no event will Prosense Technology be liable for any incidental damages, consequential damages, special damages, punitive damages, statutory damages, indirect damages, loss of profits, loss of revenues, or loss of use, even if informed of the possibility of such damages.

It is understood and agreed that Prosense' liability, whether in contract, in tort, under any warranty, in negligence or otherwise shall not exceed the amount of the purchase price paid by the purchaser for the product. Under no circumstances shall Prosense be liable for special, indirect, or consequential damages. The price stated for the product is a consideration limiting Prosense' liability. No action, regardless of form, arising out of the transactions under this warranty may be brought by the purchaser more than one year after the cause of actions has occurred. To the extent permitted by applicable law, these limitations and exclusions will apply regardless of whether liability arises from breach of contract, warranty, tort (including but not limited to negligence), by operation of law, or otherwise.